

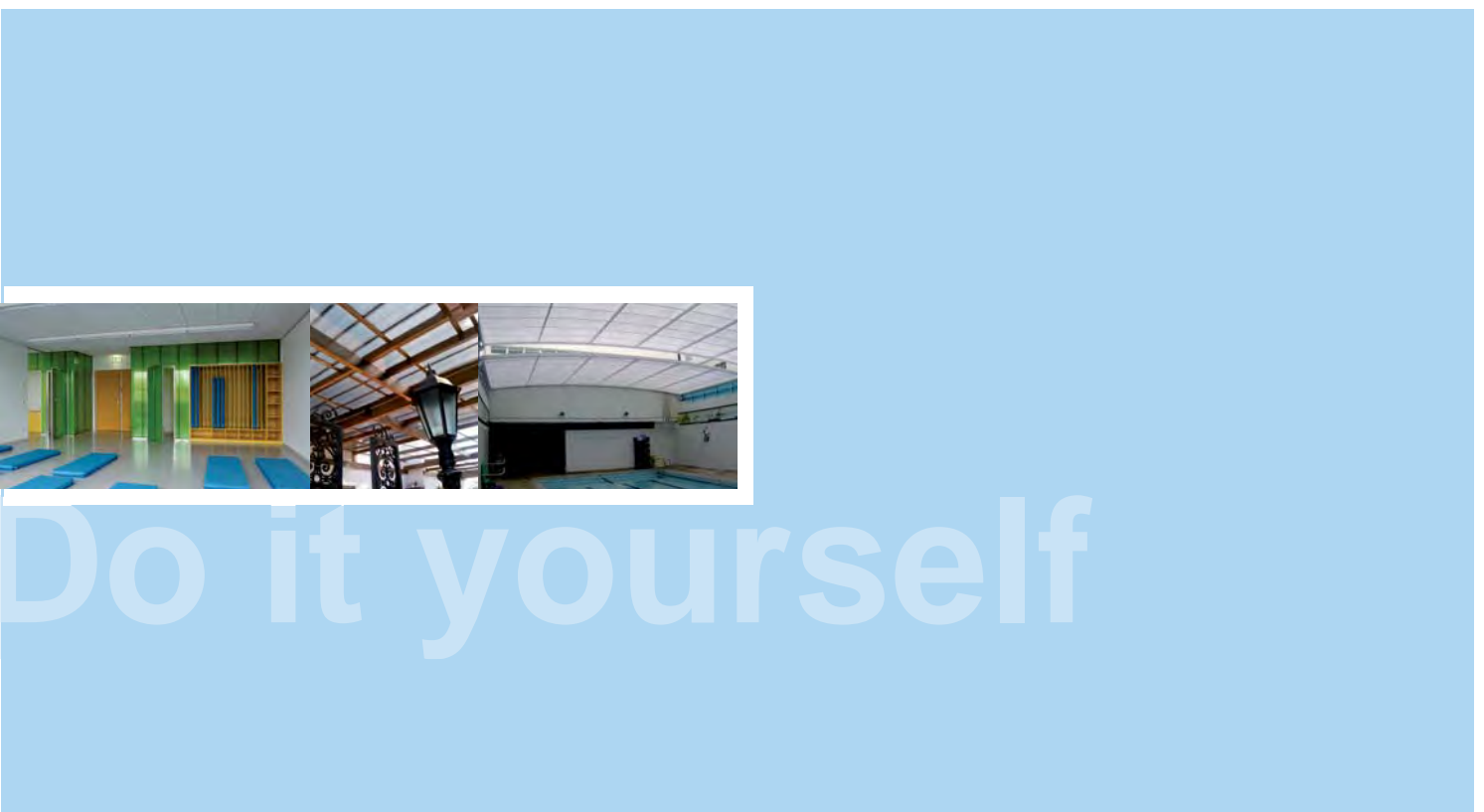

Do it yourself

Do it yourself



Do it yourself

Advantages

- Polycarbonate is a crystal clear, high impact thermoplastic
- Temperature resistance from -40 to +115°C, temporarily up to 130°C
- Unchanged impact resistance within these temperatures
- good long term performance through UV protection
- 10 years warranty against yellowing - ageing - hail stone
- translucent with excellent thermal properties

Applications

- Facade cladding and glazing
- Winter gardens
- Conservatories
- Roofing constructions
- Pergolas
- Light-bands
- Canopies
- Interior applications
- Carports

Panels

Panels are connected via the tongue and groove joint to construct walls and roofs of varying sizes. With minimal alloy components the systems are both fast and easy to install, thus ideal for home DIY.

	Panel	Up-value W/m ² K**	Weight kg/m ²	Building width (mm)	Thickness (mm)
333	2333-16-4	approx. 2.1 W/m ² K	approx. 2.4	333 +/- 1%	16
	2333-20-4	approx. 2.0 W/m ² K	approx. 2.6	333 +/- 1%	20

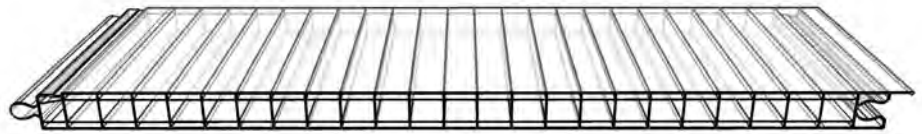

PC 2333-16-4

Colours

Standard: crystal / opal

Color version: from 300 m²



PC 2333-20-4

Colours

Standard: crystal / opal

Color version: from 300 m²

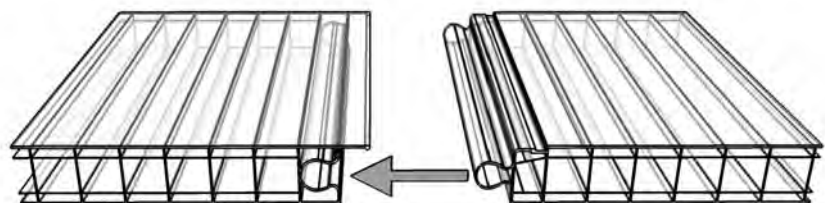

Tongue and groove joint

** Up-values

All Up-values are approximate values / reference values.





 RT-Thermolight
RT-Thermolight

 Multi Wall Sheets
Hohlkammerscheiben

 Windows
Fenster

 U-Panels
U-Paneele

Perimeter frame profiles

The aluminium profiles are available mill finished or anodized or can be powder coated to any RAL colour. The gaskets are made of TPE.

PC 2333-16-4 / 2333-20-4 System design example

- 1 PC 2333-16-4 / 2333-20-4
- 2 Fastener 49401602
- 3 Aluminium profile 461640 / 462040

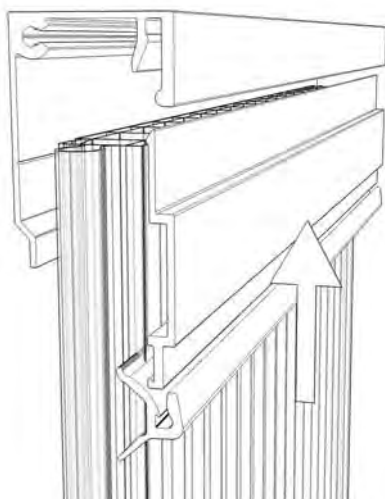
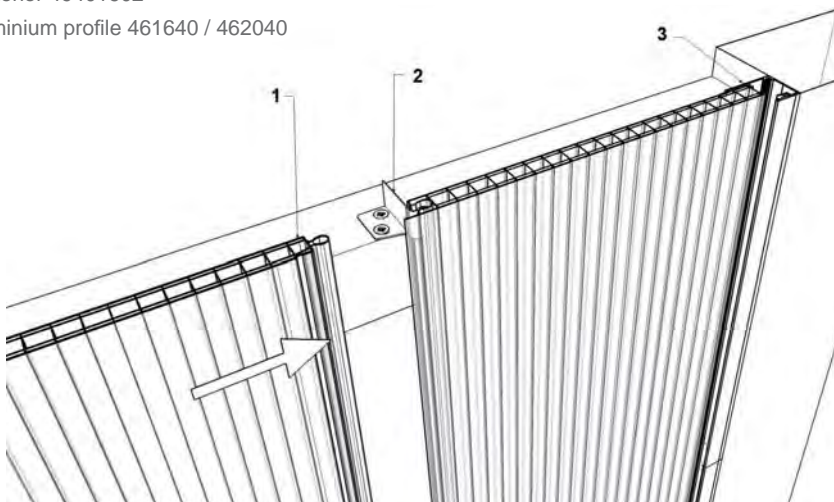

Aluminium profile 461640 / 462040
Front plate 492001
Gasket 902901

16 mm applications



16 and 20 mm applications

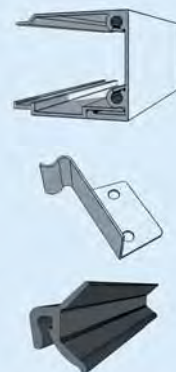

Profiles / components

It is mandatory to observe the installation guidelines and general information.

RODECA GmbH
Freiherr-vom-Stein-Straße 165
D-45473 Mülheim an der Ruhr
Fon +49 (0) 208 76502-0 | Fax +49 (0) 208 76502-11
info@rodeca.de | www.rodeca.de

Do it yourself

 Translucent Building Elements
Translucent Building Elements

 Multi Function Panels
Multi-Funktions- Paneele

Do it yourself

Panels

The Multi Function Panels are available in 3mm and 10mm thickness. Both can be used for flat and curved facades or roofing applications in varying colours.

250

Panel	Up-value W/m ² K**	Weight (kg/m ²)	Building width (mm)	Thickness (mm)
2253-2	approx. 4.0 W/m ² K	approx. 1.7	250 +/- 1%	3
2250-10-4	approx. 2.5 W/m ² K	approx 2.2	250 +/- 1%	10

End caps

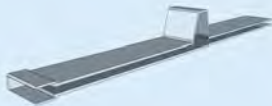

PC 2253-2

Colours

Standard: crystal and silver

Color version: from 150 m²

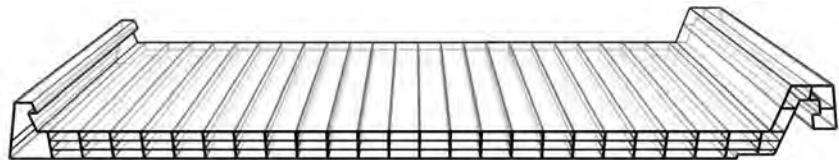

PC 2250-10-4

Colours

Standard: crystal and opal

Color version: from 300 m²

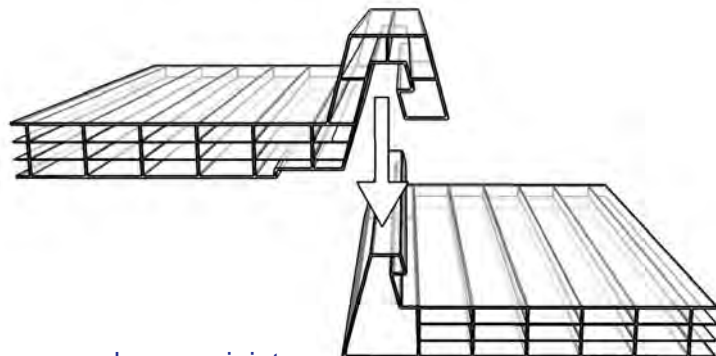

Tongue and groove joint

** Up-values

All Up-values are approximate values / reference values.

Applications

- Facade cladding and glazing
- Winter gardens
- Conservatories
- Roofing constructions
- Pergolas
- Light-bands
- Canopies
- Interior applications
- Carports





RT-Thermolight
RT-Thermolight

Multi Wall Sheets
Hohlkammerscheiben

Windows
Fenster

U-Panels
U-Paneele

Systems

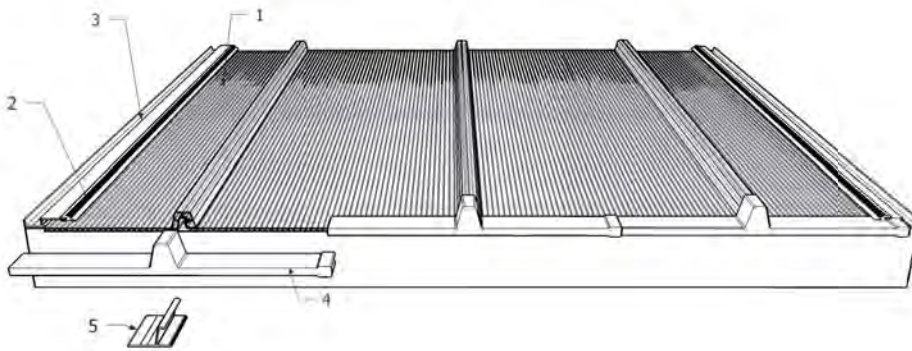

PC 2253-2

- | | |
|-----------------|-------------------|
| 1 PC 2253-2 | 3 Profile 500664 |
| 2 Gasket 902110 | 4 End cap 395001 |
| | 5 Fastener 494003 |

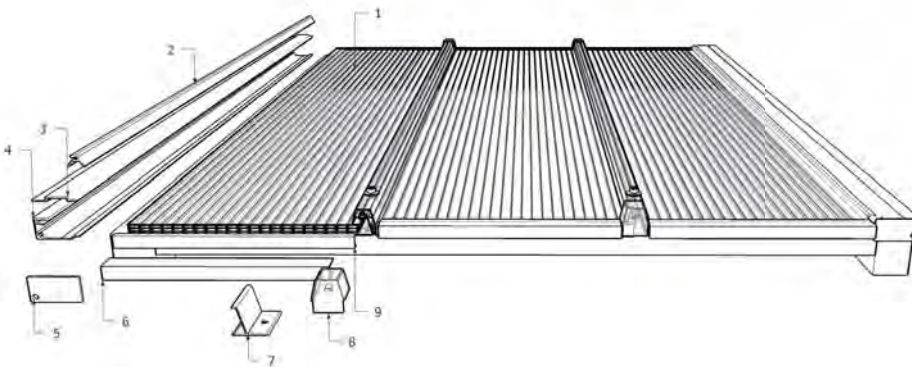

PC 2250-10-4

- | | | |
|-----------------------|-----------------------------|------------------------|
| 1 PC 2250-10-4 | 4 Profile 461040 | 7 Fastener 494004 |
| 2 Gasket 902110 | 5 Cover plate 465010 | 8 End cap 395006 |
| 3 Clamp batten 492001 | 6 Aluminum U-Profile 461011 | 9 Taping of panel ends |

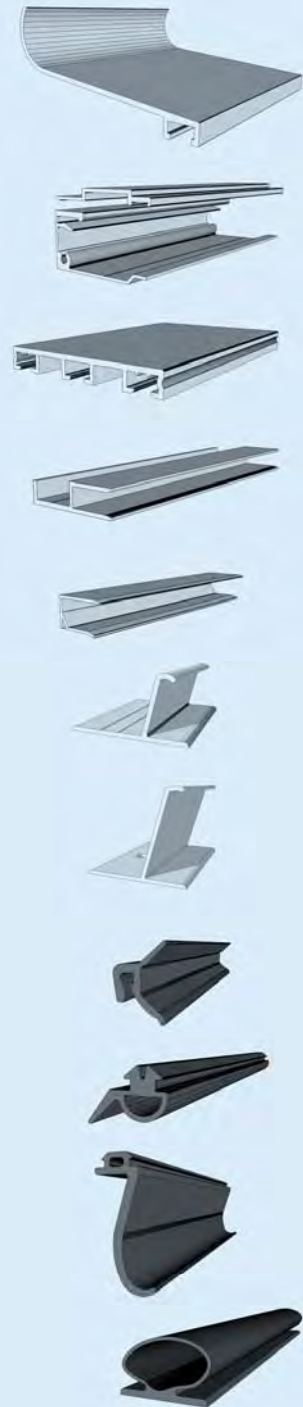

Profiles / components

It is mandatory to observe the installation guidelines and general information.

RODECA GmbH
 Freiherr-vom-Stein-Straße 165
 D-45473 Mülheim an der Ruhr
 Fon +49 (0) 208 76502-0 | Fax +49 (0) 208 76502-11
 info@rodeca.de | www.rodeca.de



Do it yourself

Panels

The Multicolor panel provides numerous opportunities for wall and facade designing. Polycarbonate tubes in varying shapes and various colours can be shifted into the panels middle chamber. This allows to create different patterns and colour accents. This makes individual design, even for small projects like partitions, affordable.

Multicolor



rectangular tubes
Item no.: 37r1011060



concave tubes
Item no.: 37k1011060



triangular tubes
Item no.: 37d1011060

40	Panel	Up-value W/m ² K**	Weight kg/m ²	Building width (mm)	Thickness (mm)
	2540-4MC	1.3-1.6 W/m ² K	approx. 4.0	500+/- 1%	40

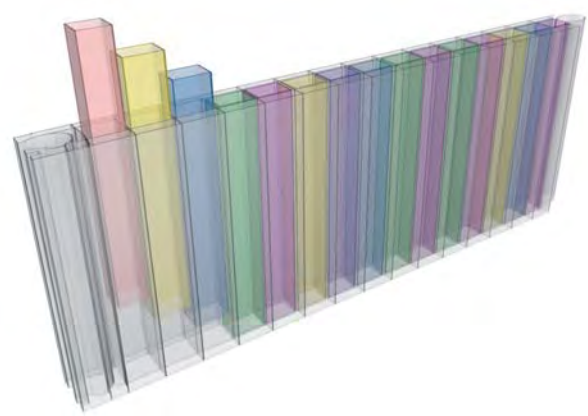
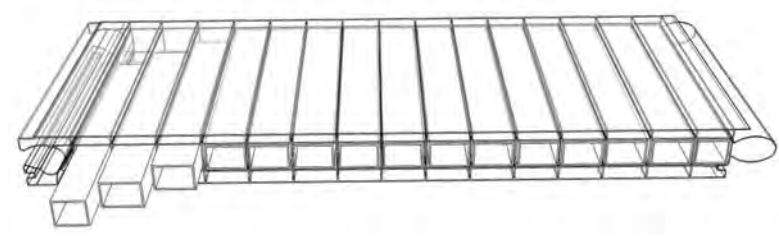
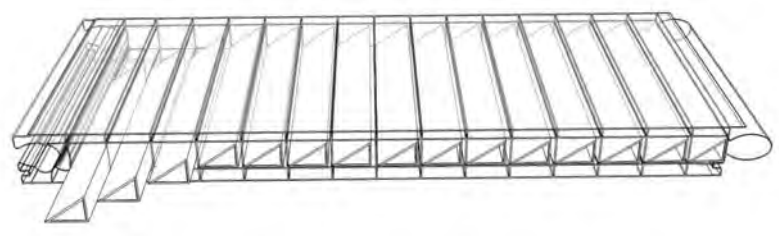
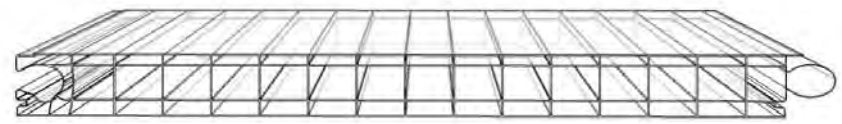

Applications

- Facade claddings
- Interior applications
- Exhibition stand constructions
- Partitions
- Pergolas
- Light bands



**** Up-values**

All Up-values are approximate values / reference values.



RT-Thermolight
RT-Thermolight

Multi Wall Sheets
Hohlkammerscheiben

Windows
Fenster

U-Panels
U-Paneele

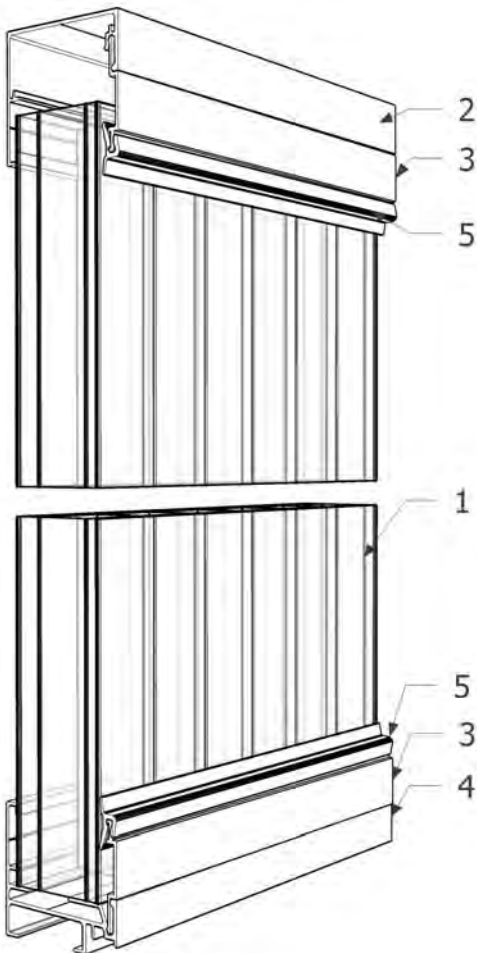
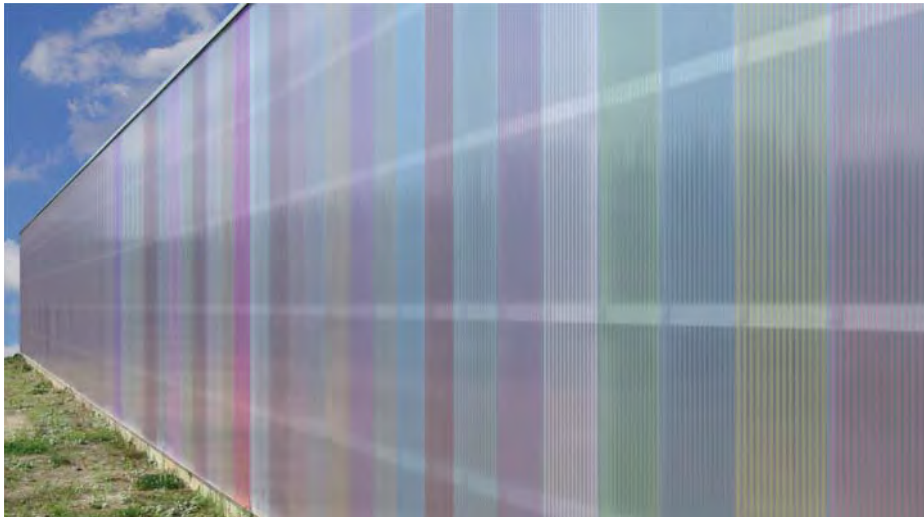

PC 2540-4 Multicolor

1. PC 2540-4 Multicolor
2. Top and side aluminum frame profile 420040
3. Aluminum front plate 492001
4. Aluminum base profile 490031
5. Gasket 902901

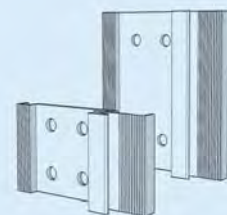
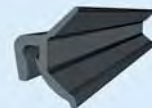
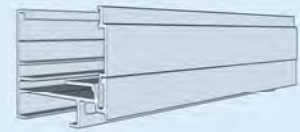

Profiles / components

It is mandatory to observe the installation guidelines and general information.

RODECA GmbH
 Freiherr-vom-Stein-Straße 165
 D-45473 Mülheim an der Ruhr
 Fon +49 (0) 208 76502-0 | Fax +49 (0) 208 76502-11
 info@rodeca.de | www.rodeca.de



ООО «Торгово-Строительная Компания Империя»

109382, Россия, г.Москва, ул.Нижние поля, 31
+7(495)646-81-65
info@tbc-empire.ru
www.tbc-empire.ru

LLC TBC Empire

109382, Russia, Moscow, Nizhniye polya,31
+7(495)646-81-65
info@tbc-empire.ru
www.tbc-empire.ru

The RODECA product groups overview /
Die RODECA Produktgruppen im Überblick:

 **Translucent Building Elements**
Lichtbauelemente

 **Multi Wall Sheets**
Hohlkammerscheiben

 **Multi Function Panels**
Multi-Funktions-Paneele

 **U-Panels**
U-Paneele

 **RT-Thermolight**
RT-Thermolight

 **Windows**
Fenster

 **Do it yourself**
Do it yourself